

Retaining magnets

disc-shaped, with bore or female thread

SPECIFICATION

Housing

Steel, zinc plated

Materials of the magnet:

Version with bore

Hard ferrite **HF**

temperature resistant up to 200 °C

NdFeB **ND**

Neodymium, iron, boron

temperature resistant up to 80 °C

SmCo **SC**

Samarium, cobalt

temperature resistant up to 280 °C

Version with female thread

Hard ferrite **HF**

temperature resistant up to 200 °C



INFORMATION

Retaining magnets GN 50.4 are a shielded magnetic system.

To ensure that the magnetic properties (adhesive forces) are not impaired, the fixing screws must be made of **non-magnetic** material (magnetic not conductive).

- More information to retaining magnets (see page 2022)

ACCESSORY

- Holding discs GN 70 (see page 2051)

- Adhesive discs GN 70.1 (see page 2051)

View of magnetic surface

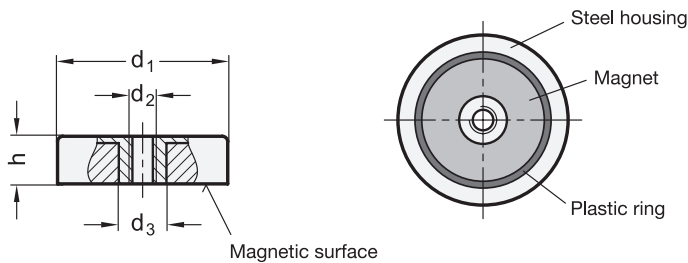

GN 50.4 - with female thread

Description	d1	h	d2	d3	Nominal magnetic forces in N	△
GN 50.4-HF-25-7-M4	25 ±0.1	9.2 ±0.1	M4	5.2	36	15
GN 50.4-HF-32-7-M4	32 ±0.1	7 +0.3/-0.2	M4	5.2	75	25
GN 50.4-HF-40-8-M4	40 +0.2/-0.1	8 +0.4/-0.2	M4	5.2	90	52
GN 50.4-HF-50-10-M6	50 +0.2/-0.1	10 +0.5/-0.2	M6	12	170	90
GN 50.4-HF-50-10-M8	50 +0.2/-0.1	10 +0.5/-0.2	M8	12	170	92
GN 50.4-HF-63-14-M8	63 +0.3/-0.1	14 +0.5/-0.2	M8	13	290	209
GN 50.4-HF-80-10-M8	80 +0.3/-0.1	10 +0.5/-0.2	M8	12	450	239
GN 50.4-HF-80-18-M8	80 +0.3/-0.1	18 +0.5/-0.2	M8	14.5	540	400
GN 50.4-HF-80-18-M10	80 +0.3/-0.1	18 +0.5/-0.2	M10	14.5	540	479

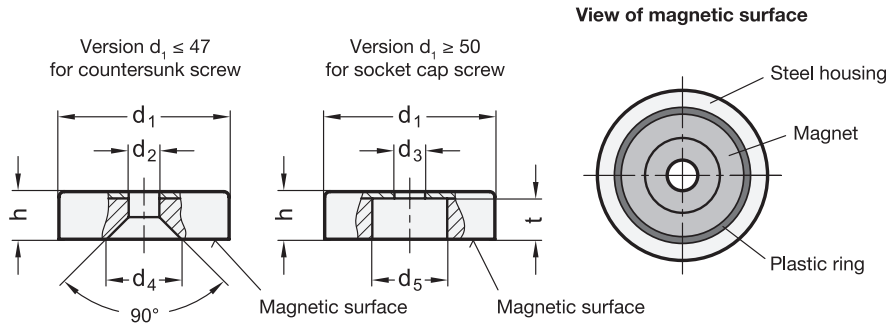

GN 50.4 - with bore

Description	d1	h	d2	d3	d4	d5	t	Nominal magnetic forces in N	⚖️
GN 50.4-HF-16-4.5-3.5	16 ±0.1	4.5 +0.2/-0.1	3.5	-	7	-	-	14	4
GN 50.4-HF-20-6-4.3	20 ±0.1	6 +0.2/-0.1	4.3	-	10	-	-	27	9
GN 50.4-HF-25-7-5.5	25 ±0.1	7 +0.3/-0.2	5.5	-	12	-	-	36	16
GN 50.4-HF-32-7-5.5	32 ±0.1	7 +0.3/-0.2	5.5	-	12	-	-	72	27
GN 50.4-HF-40-8-5.5	40 +0.2/-0.1	8 +0.4/-0.2	5.5	-	13	-	-	90	52
GN 50.4-HF-50-10-8.5	50 +0.2/-0.1	10 +0.5/-0.2	-	8.5	-	22	8.5	180	84
GN 50.4-HF-57-11-6.5	57 +0.2/-0.1	11 +0.5/-0.2	-	6.5	-	24	9	230	130
GN 50.4-HF-63-14-6.5	63 +0.3/-0.1	14 +0.5/-0.2	-	6.5	-	24	12	290	197
GN 50.4-HF-80-10-6.5	80 +0.3/-0.1	10 +0.5/-0.2	-	6.5	-	32	8	450	235
GN 50.4-HF-80-18-6.5	80 +0.3/-0.1	18 +0.5/-0.2	-	6.5	-	11.5	15	540	458
GN 50.4-HF-83-18-10.5	83 +0.3/-0.1	18 +0.5/-0.2	-	10.5	-	32	15	600	444
GN 50.4-HF-100-22-10.5	100 +0.5/-0.1	22 +0.5/-0.2	-	10.5	-	34	18	680	815
GN 50.4-ND-10-4.5-2.6	10 ±0.1	4.5	2.6	-	5.2	-	-	19	2
GN 50.4-ND-13-4.5-3.5	13 ±0.1	4.5	3.5	-	6.6	-	-	40	4
GN 50.4-ND-16-4.5-3.5	16 ±0.1	4.5 ±0.1	3.5	-	6.6	-	-	75	6
GN 50.4-ND-20-6-4.5	20 ±0.1	6 ±0.1	4.5	-	9.3	-	-	105	13
GN 50.4-ND-25-7-4.5	25 ±0.1	7 ±0.2	4.5	-	9	-	-	160	25
GN 50.4-ND-32-7-5.5	32 ±0.1	7 ±0.2	5.5	-	11	-	-	310	42
GN 50.4-ND-40-8-5.5	40 ±0.1	8 ±0.2	5.5	-	10.3	-	-	500	77
GN 50.4-ND-47-9.2-8.5	47 +0.2/-0.1	9.2 ±0.2	8.5	-	17.3	-	-	740	97
GN 50.4-SC-16-4.5-3.5	16 ±0.1	4.5 ±0.1	3.5	-	6.6	-	-	57	6
GN 50.4-SC-20-6-4.5	20 ±0.1	6 ±0.1	4.5	-	9.3	-	-	81	13
GN 50.4-SC-25-7-4.5	25 ±0.1	7 ±0.1	4.5	-	9	-	-	105	25
GN 50.4-SC-32-7-5.5	32 ±0.1	7 ±0.1	5.5	-	11	-	-	235	40
GN 50.4-SC-40-8-5.5	40 ±0.1	8 ±0.1	5.5	-	10.3	-	-	540	75

